

SN75177B, SN75178B DIFFERENTIAL BUS REPEATERS

SLLS002C – D2606, JULY 1985 – REVISED FEBRUARY 1993

- Meets EIA Standards RS-422-A and RS-485 and CCITT Recommendations V.11 and X.27
- Designed for Multipoint Transmission on Long Bus Lines in Noisy Environments
- 3-State Outputs
- Bus Voltage Range . . . –7 V to 12 V
- Positive and Negative Current Limiting
- Driver Output Capability . . . 60 mA Max
- Driver Thermal Shutdown Protection
- Receiver Input Impedance . . . 12 k Ω Min
- Receiver Input Sensitivity . . . ± 200 mV
- Receiver Input Hysteresis . . . 50 mV Typ
- Operates From Single 5-V Supply
- Low Power Requirements

SN75177B . . . D OR P PACKAGE
(TOP VIEW)

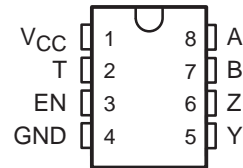

SN75178B . . . P PACKAGE
(TOP VIEW)

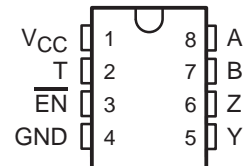

THE SN75177B IS NOT
RECOMMENDED FOR NEW DESIGN

description

The SN75177B and SN75178B differential bus repeaters are monolithic integrated devices each designed for one-way data communication on multipoint bus transmission lines. These devices are designed for balanced transmission bus line applications and meet EIA Standard RS-422-A and RS-485 and CCITT Recommendations V.11 and X.27. Each device is designed to improve the performance of the data communication over long bus lines. The SN75177B and SN75178B are identical except for the complementary enable inputs, which allow the devices to be used in pairs for bidirectional communication.

The SN75177B and SN75178B feature positive- and negative-current limiting 3-state outputs for the receiver and driver. The receiver features high input impedance, input hysteresis for increased noise immunity, and input sensitivity of ± 200 mV over a common-mode input voltage range of –7 V to 12 V. The driver features thermal shutdown for protection from line fault conditions. Thermal shutdown is designed to occur at a junction temperature of approximately 150°C. The driver is designed to drive current loads up to 60 mA maximum.

The SN75177B and SN75178B are designed for optimum performance when used on transmission buses employing the SN75172 and SN75174 differential line drivers, SN75173 and SN75175 differential line receivers, or SN75176B bus transceiver.

Function Tables

SN75177B

DIFFERENTIAL INPUTS A – B	ENABLE EN	OUTPUTS		
		T	Y	Z
$V_{ID} \geq 0.2$ V	H	H	H	L
-0.2 V < $V_{ID} < 0.2$ V	H	?	?	?
$V_{ID} \leq 0.2$ V	H	L	L	H
X	L	Z	Z	Z

SN75178B

DIFFERENTIAL INPUTS A – B	ENABLE $\overline{\text{EN}}$	OUTPUTS		
		T	Y	Z
$V_{ID} \geq 0.2$ V	L	H	H	L
-0.2 V < $V_{ID} < 0.2$ V	L	?	?	?
$V_{ID} \leq 0.2$ V	L	L	L	H
X	H	Z	Z	Z

H = high level, L = low level, ? = indeterminate, X = irrelevant, Z = impedance (off)

PRODUCTION DATA information is current as of publication date. Products conform to specifications per the terms of Texas Instruments standard warranty. Production processing does not necessarily include testing of all parameters.

TEXAS
INSTRUMENTS

POST OFFICE BOX 655303 • DALLAS, TEXAS 75265

Copyright © 1993, Texas Instruments Incorporated

SN75177B, SN75178B DIFFERENTIAL BUS REPEATERS

SLLS002C – D2606, JULY 1985 – REVISED FEBRUARY 1993

logic symbols†

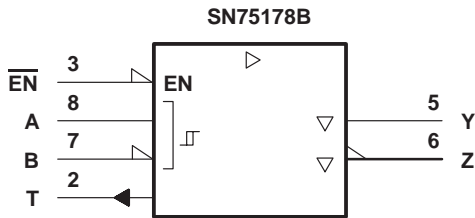
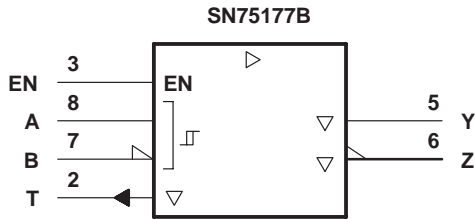

logic diagrams (positive logic)

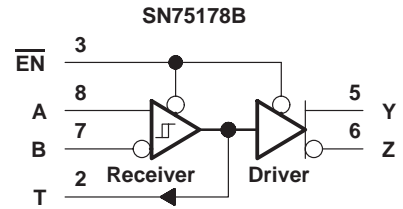
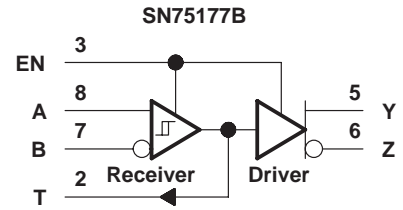

† These symbols are in accordance with ANSI/IEEE Std 91-1984 and IEC Publication 617-12.

schematics of inputs and outputs

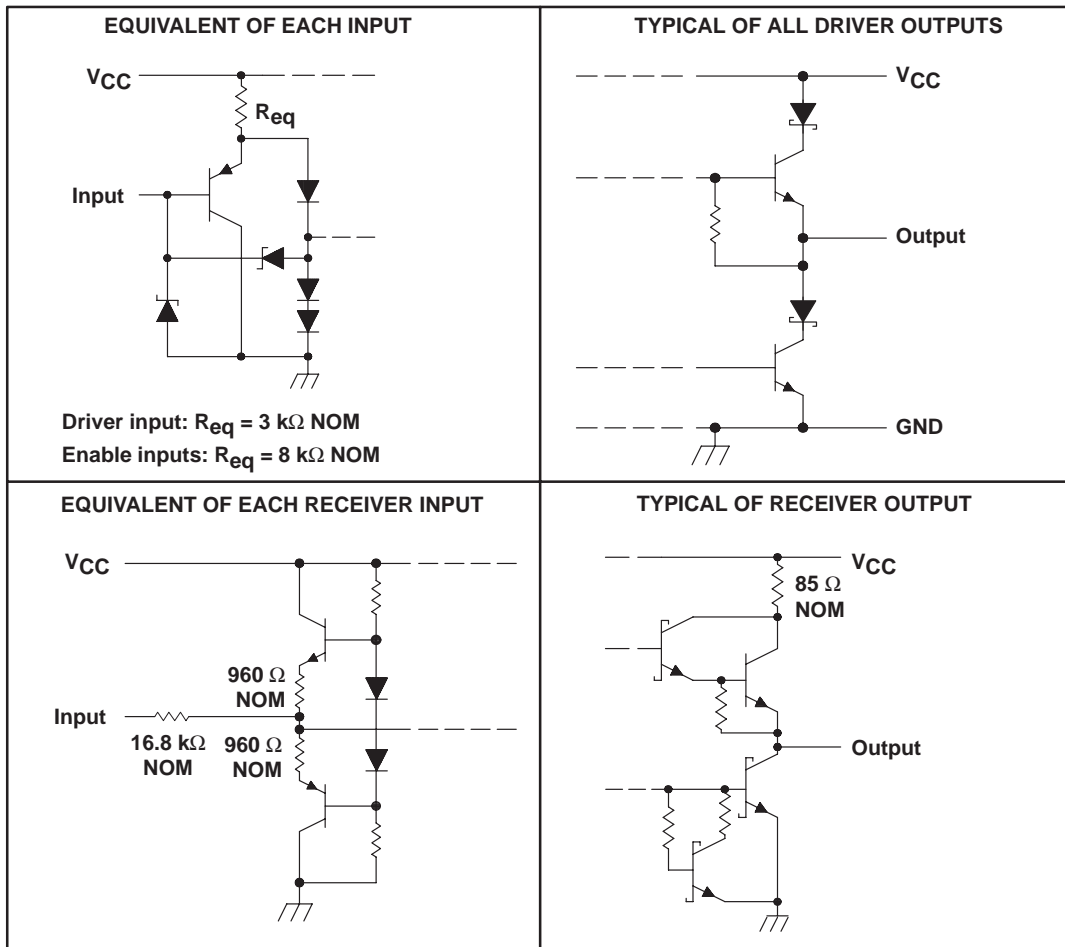

SN75177B, SN75178B DIFFERENTIAL BUS REPEATERS

SLLS002C – D2606, JULY 1985 – REVISED FEBRUARY 1993

absolute maximum ratings over operating free-air temperature range (unless otherwise noted)

Supply voltage, V_{CC} (see Note 1)	7 V
Voltage range at any bus terminal	–10 V to 15 V
Differential input voltage (see Note 2)	± 25 V
Enable input voltage	5.5 V
Continuous total dissipation	See Dissipation Rating Table
Operating free-air temperature range	0°C to 70°C
Storage temperature range	-65°C to 150°C
Lead temperature 1,6 mm (1/16 inch) from case for 10 seconds	260°C

- NOTES: 1. All voltage values, except differential input voltage, are with respect to network ground terminal.
 2. Differential input voltage is measured at the noninverting input with respect to the corresponding inverting input.

DISSIPATION RATING TABLE

PACKAGE	$T_A \leq 25^{\circ}\text{C}$ POWER RATING	DERATING FACTOR ABOVE $T_A = 25^{\circ}\text{C}$	$T_A = 70^{\circ}\text{C}$ POWER RATING
D	725 mW	5.8 mW/ $^{\circ}\text{C}$	464 mW
P	1000 mW	8.0 mW/ $^{\circ}\text{C}$	640 mW

recommended operating conditions

		MIN	NOM	MAX	UNIT
Supply voltage, V_{CC}		4.75	5	5.25	V
High-level input voltage, V_{IH}	EN or $\overline{\text{EN}}$	2			V
low-level input voltage, V_{IL}	EN or $\overline{\text{EN}}$			0.8	V
Common-mode input voltage, V_{IC}		-7^{\dagger}		12	V
Differential input voltage, V_{ID}				± 12	V
High-level output current, I_{OH}	Driver			–60	mA
	Receiver			–400	μA
Low-level output current, I_{OL}	Driver			60	mA
	Receiver			8	
Operating free-air temperature, T_A		0		70	$^{\circ}\text{C}$

\dagger The algebraic convention, where the less-positive (more-negative) limit is designated minimum, is used in this data sheet for common-mode input voltage and threshold voltage.

SN75177B, SN75178B DIFFERENTIAL BUS REPEATERS

SLLS002C – D2606, JULY 1985 – REVISED FEBRUARY 1993

DRIVER SECTION

electrical characteristics over recommended ranges of supply voltage and operating free-air temperature (unless otherwise noted)

PARAMETER	TEST CONDITIONS	MIN	TYP†	MAX	UNIT
V_{IK} Input clamp voltage	$I_I = -18 \text{ mA}$			-1.5	V
V_O Output voltage	$I_O = 0$	0		6	V
$ V_{OD1} $ Differential output voltage	$I_O = 0$	1.5		6	V
$ V_{OD2} $ Differential output voltage	$R_L = 100 \Omega$, See Figure 1	$1/2 V_{OD1}$ or $2 \S$			V
	$R_L = 54 \Omega$, See Figure 1	1.5	2.5	5	
$ V_{OD3} $ Differential output voltage	See Note 3	1.5		5	V
$\Delta V_{OD} $ Change in magnitude of differential output voltage‡	$R_L = 54 \Omega$ or 100Ω , See Figure 1			± 0.2	V
V_{OC} Common-mode output voltage				3 -1	V
$\Delta V_{OC} $ Change in magnitude of common-mode output voltage‡				± 0.2	V
I_O Output current	$V_{CC} = 0$, $V_O = -7 \text{ V to } 12 \text{ V}$			± 100	μA
I_{OZ} High-impedance-state output current	$V_O = -7 \text{ V to } 12 \text{ V}$			± 100	μA
I_{IH} High-level input current	$V_I = 2.4 \text{ V}$			20	μA
I_{IL} Low-level input current	$V_I = 0.4 \text{ V}$			-400	μA
I_{OS} Short-circuit output current	$V_O = -7 \text{ V}$			-250	mA
	$V_O = V_{CC}$			250	
	$V_O = 12 \text{ V}$			250	
I_{CC} Supply current (total package)	No load	Outputs enabled	57	70	mA
		Outputs disabled	26	35	

† All typical values are at $V_{CC} = 5 \text{ V}$ and $T_A = 25^\circ\text{C}$.

‡ $\Delta|V_{OD}|$ and $\Delta|V_{OC}|$ are the changes in magnitude of V_{OD} and V_{OC} , respectively, that occur when the input is changed from a high level to a low level.

§ The minimum V_{OD2} with a $100\text{-}\Omega$ load is either $1/2 V_{OD1}$ or 2, whichever is greater.

NOTE 3: See Figure 3.5 of EIA Standard RS-485.

switching characteristics, $V_{CC} = 5 \text{ V}$, $T_A = 25^\circ\text{C}$

PARAMETER	TEST CONDITIONS	MIN	TYP	MAX	UNIT
t_{dD} Differential-output delay time	$R_L = 54 \Omega$, See Figure 3		15	20	ns
t_{tD} Differential-output transition time			20	30	ns
t_{PZH} Output enable time to high level	$R_L = 110 \Omega$, See Figure 4		85	120	ns
t_{PZL} Output enable time to low level	$R_L = 110 \Omega$, See Figure 5		40	60	ns
t_{PHZ} Output disable time from high level	$R_L = 110 \Omega$, See Figure 4		150	250	ns
t_{PLZ} Output disable time from low level	$R_L = 110 \Omega$, See Figure 5		20	30	ns

SN75177B, SN75178B DIFFERENTIAL BUS REPEATERS

SLLS002C – D2606, JULY 1985 – REVISED FEBRUARY 1993

SYMBOL EQUIVALENTS

DATA SHEET PARAMETER	RS-422-A	RS-485
V_O	V_{oa}, V_{ob}	V_{oa}, V_{ob}
$ V_{OD1} $	V_o	V_o
$ V_{OD2} $	$V_t (R_L = 100 \Omega)$	$V_t (R_L = 54 \Omega)$
$ V_{OD3} $		V_t (Test Termination Measurement 2)
$\Delta V_{OD} $	$ V_t - \bar{V}_t $	$ V_t - \bar{V}_t $
V_{OC}	$ V_{OS} $	$ V_{OS} $
$\Delta V_{OC} $	$ V_{OS} - \bar{V}_{OS} $	$ V_{OS} - \bar{V}_{OS} $
I_{OS}	$ I_{sa} , I_{sb} $	
I_O	$ I_{xa} , I_{xb} $	I_{ia}, I_{ib}

RECEIVER SECTION

electrical characteristics over recommended ranges of common-mode input voltage, supply voltage, and operating free-air temperature (unless otherwise noted)

PARAMETER	TEST CONDITIONS	MIN	TYP†	MAX	UNIT
V_{T+} Positive-going input threshold voltage	$V_O = 2.7 \text{ V}$, $I_O = -0.4 \text{ mA}$			0.2	V
V_{T-} Negative-going input threshold voltage	$V_O = 0.5 \text{ V}$, $I_O = 8 \text{ mA}$	-0.2‡			V
V_{hys} Input hysteresis ($V_{T+} - V_{T-}$)			50		mV
V_{IK} Input clamp voltage at EN	$I_I = -18 \text{ mA}$			-1.5	V
V_{OH} High-level output voltage	$V_{ID} = 200 \text{ mV}$, See Figure 2		2.7		V
V_{OL} Low-level output voltage	$V_{ID} = -200 \text{ mV}$, See Figure 2			0.45	V
I_{OZ} High-impedance-state output current	$V_O = 0.4 \text{ V to } 2.4 \text{ V}$			20 -400	μA
I_I Line input current	Other input at 0 V, See Note 4			1 -0.8	mA
I_{IH} High-level enable-input current	$V_{IH} = 2.7 \text{ V}$			20	μA
I_{IL} Low-level enable-input current	$V_{IL} = 0.4 \text{ V}$			-200	μA
r_i Input resistance			12		kΩ
I_{OS} Short-circuit output current		-15		-85	mA
I_{CC} Supply current (total package)	No load			57 26	mA
				70 35	

† All typical values are at $V_{CC} = 5 \text{ V}$, $T_A = 25^\circ\text{C}$.

‡ The algebraic convention, where the less-positive (more-negative) limit is designated minimum, is used in this data sheet for common-mode input voltage and threshold voltage levels only.

NOTE 4: Refer to EIA Standard RS-422 for exact conditions.

switching characteristics, $V_{CC} = 5 \text{ V}$, $T_A = 25^\circ\text{C}$

PARAMETER	TEST CONDITIONS	MIN	TYP	MAX	UNIT
t_{PLH} Propagation delay time, low-to-high level output	$V_{ID} = -1.5 \text{ V to } 1.5 \text{ V}$, $C_L = 15 \text{ pF}$, See Figure 6		19	35	ns
t_{PHL} Propagation delay time, high-to-low level output			30	40	
t_{PZH} Output enable time to high level	$C_L = 15 \text{ pF}$, See Figure 7		10	20	ns
t_{PZL} Output enable time to high level			12	20	
t_{PHZ} Output disable time from high level	$C_L = 15 \text{ pF}$, See Figure 8		25	35	ns
t_{PLZ} Output disable time from low level			17	25	



SN75177B, SN75178B DIFFERENTIAL BUS REPEATERS

SLLS002C – D2606, JULY 1985 – REVISED FEBRUARY 1993

PARAMETER MEASUREMENT INFORMATION

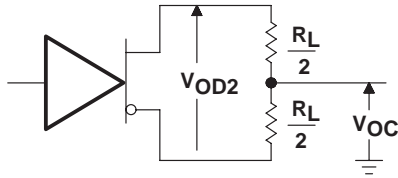

Figure 1. Driver V_{OD2} and V_{OC}

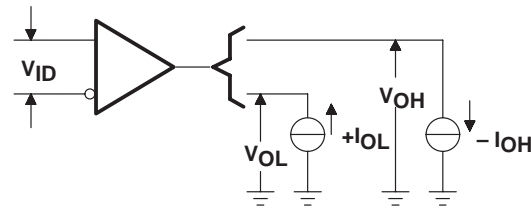
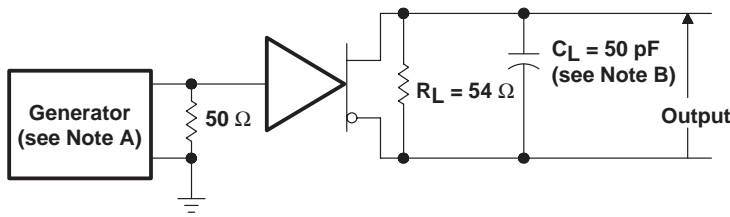
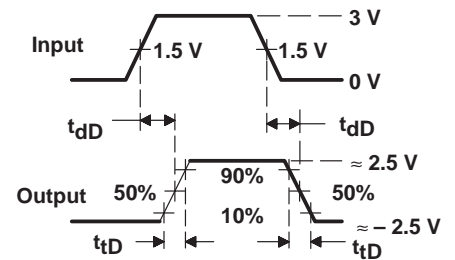

Figure 2. Receiver V_{OH} and V_{OL}



TEST CIRCUIT



VOLTAGE WAVEFORMS

Figure 3. Driver Differential-Output Test Circuit and Voltage Waveforms

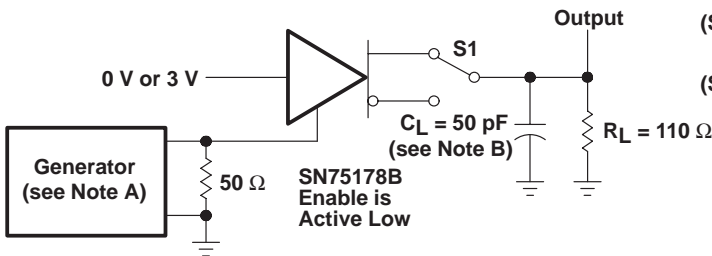

TEST CIRCUIT

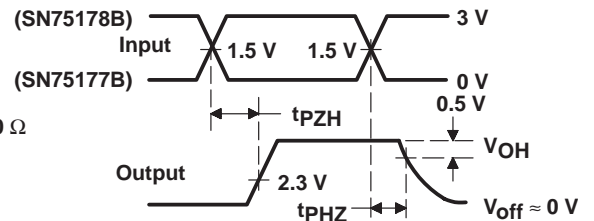

VOLTAGE WAVEFORMS

Figure 4. Driver Enable and Disable Times

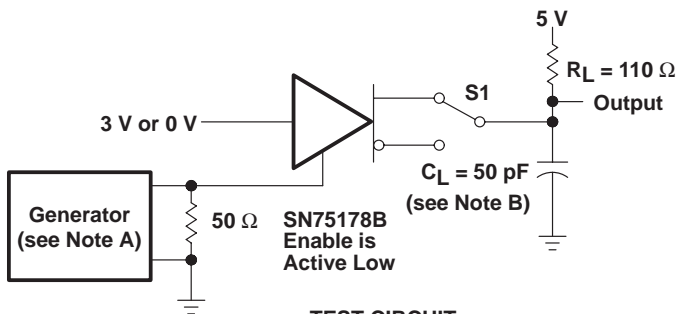

TEST CIRCUIT

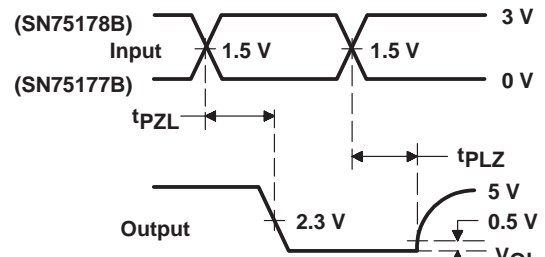

VOLTAGE WAVEFORMS

Figure 5. Driver Enable and Disable Times

NOTES: A. The input pulse is supplied by a generator having the following characteristics: PRR \leq 1 MHz, 50% duty cycle, $t_r \leq$ 6 ns, $t_f \leq$ 6 ns, $Z_0 = 50 \Omega$.

B. C_L includes probe and jig capacitance.

PARAMETER MEASUREMENT INFORMATION

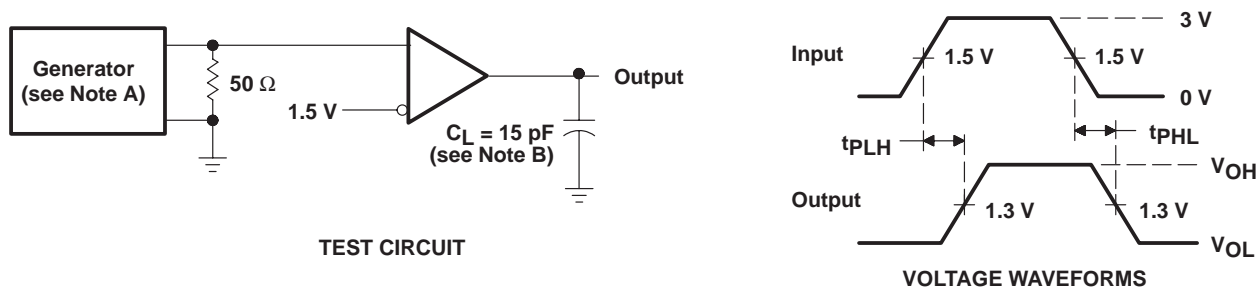

Figure 6. Receiver Propagation Delay Times

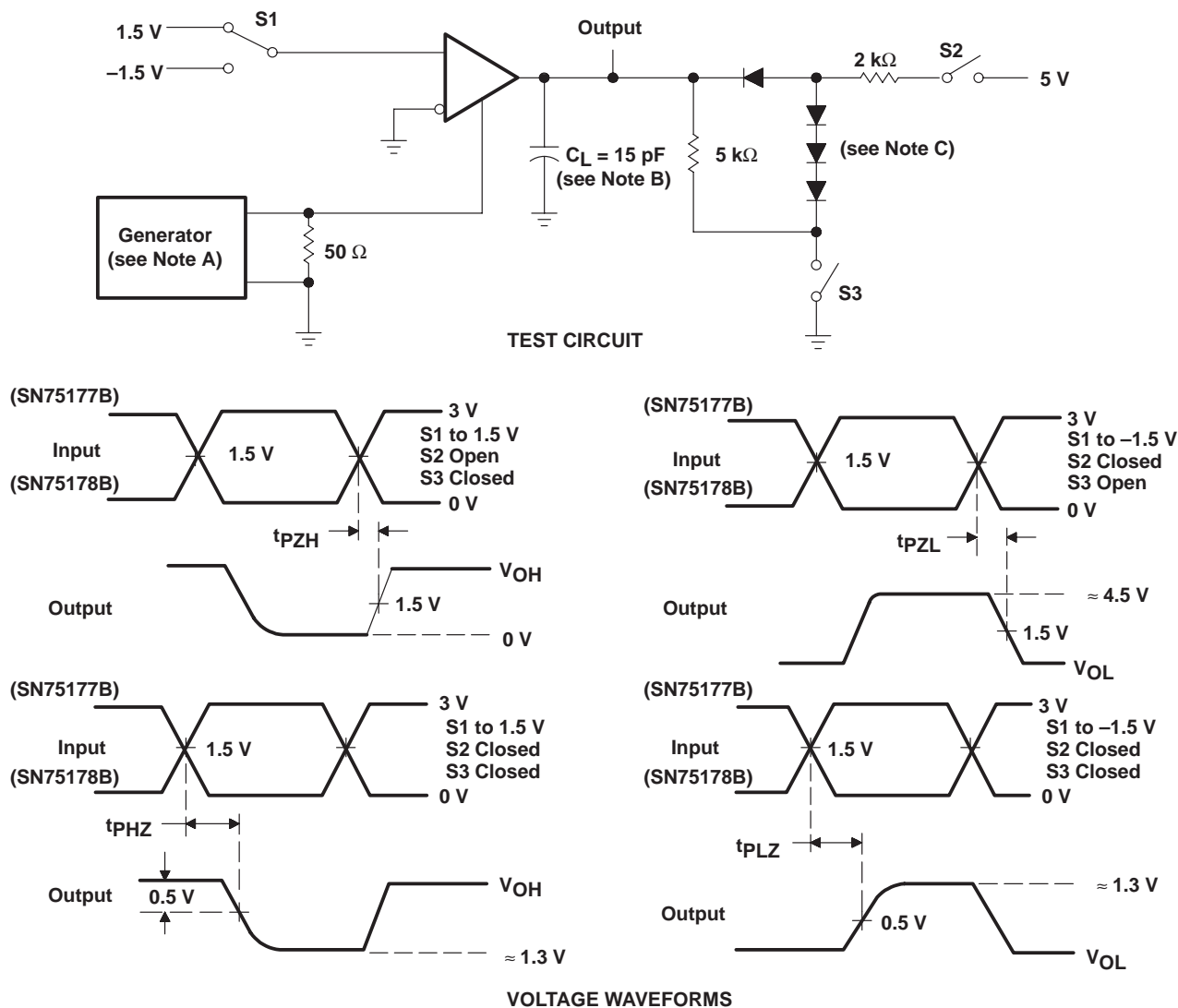

Figure 7. Receiver Output Enable and Disable Times

- NOTES: A. The input pulse is supplied by a generator having the following characteristics: PRR \leq 1 MHz, 50% duty cycle, $t_r \leq$ 6 ns, $t_f \leq$ 6 ns, $Z_0 = 50 \Omega$.
 B. C_L includes probe and jig capacitance.
 C. All diodes are 1N916 or equivalent.

SN75177B, SN75178B DIFFERENTIAL BUS REPEATERS

SLLS002C – D2606, JULY 1985 – REVISED FEBRUARY 1993

TYPICAL CHARACTERISTICS

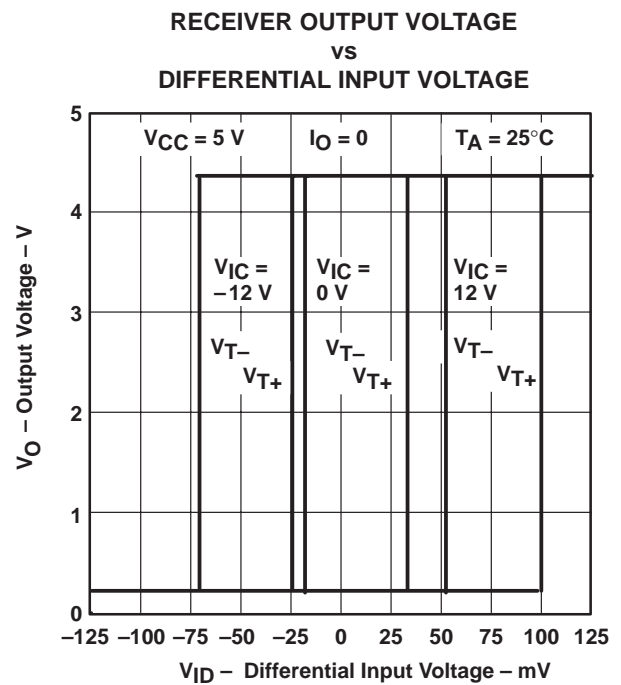
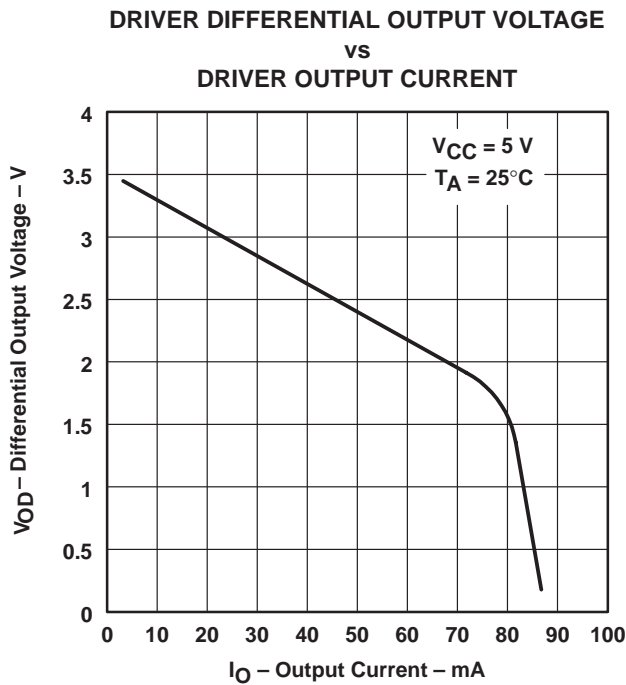
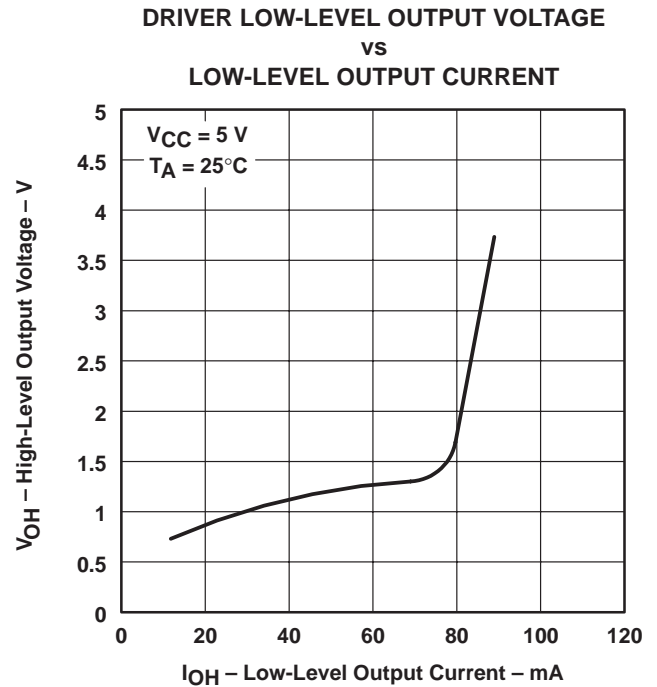
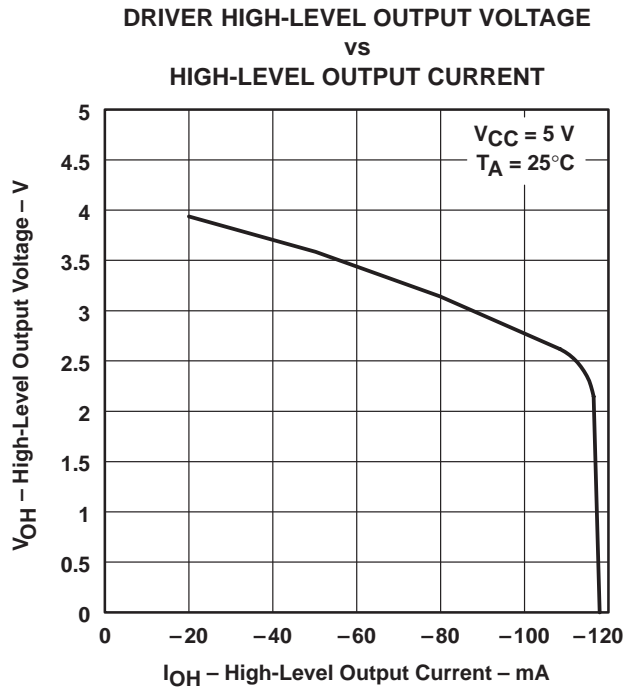

TYPICAL CHARACTERISTICS

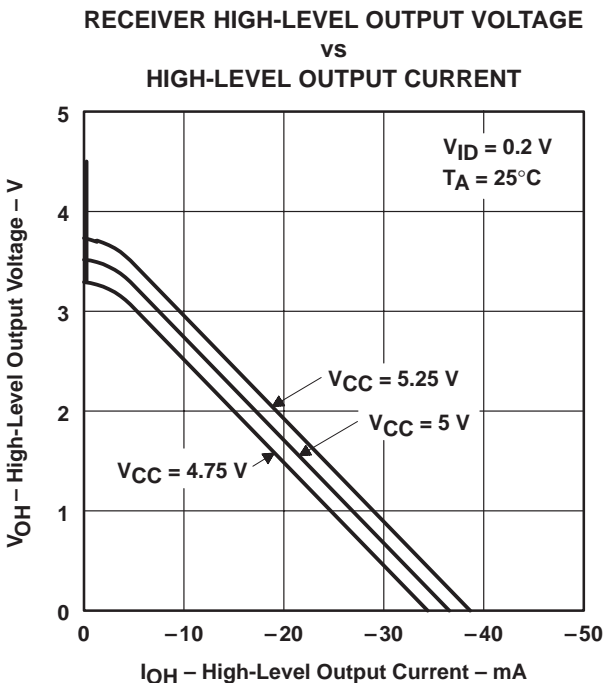

Figure 12

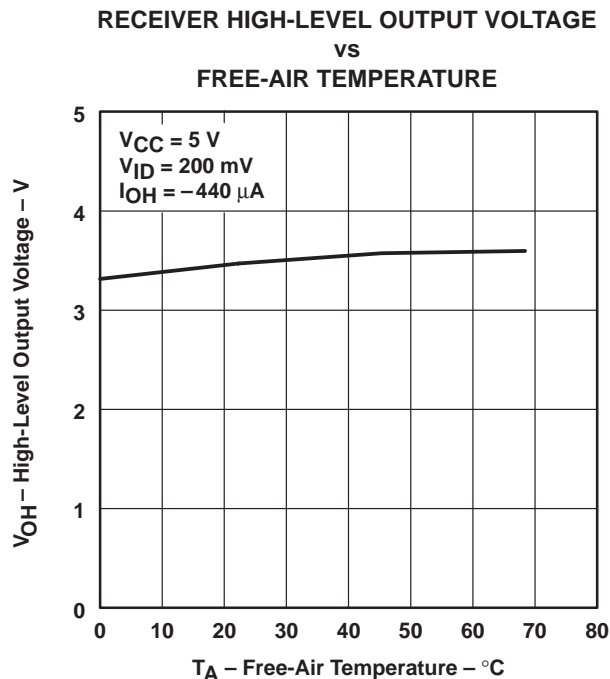

Figure 13

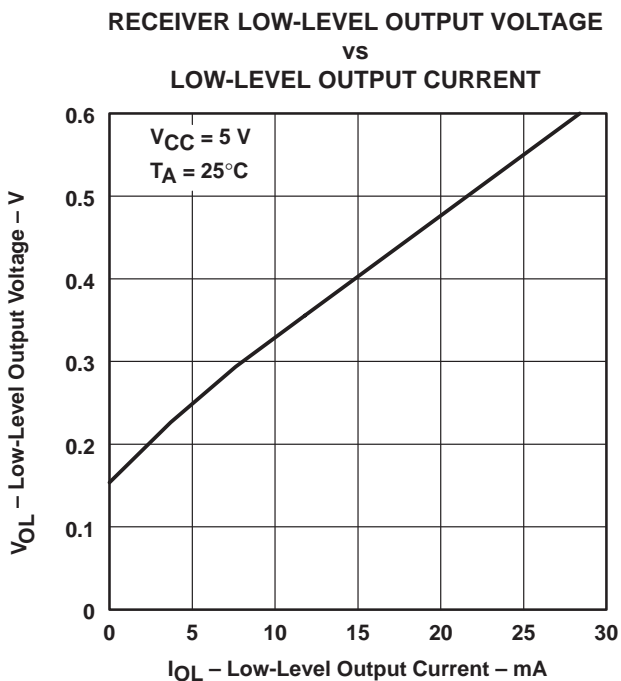

Figure 14

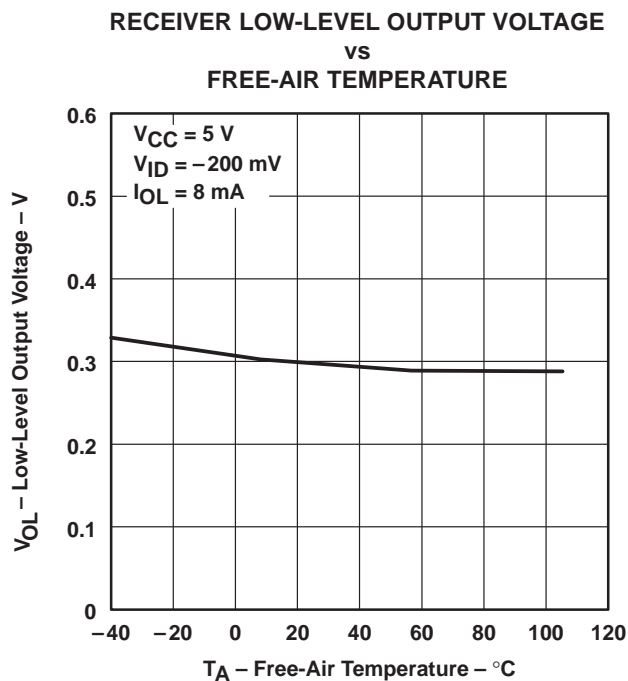
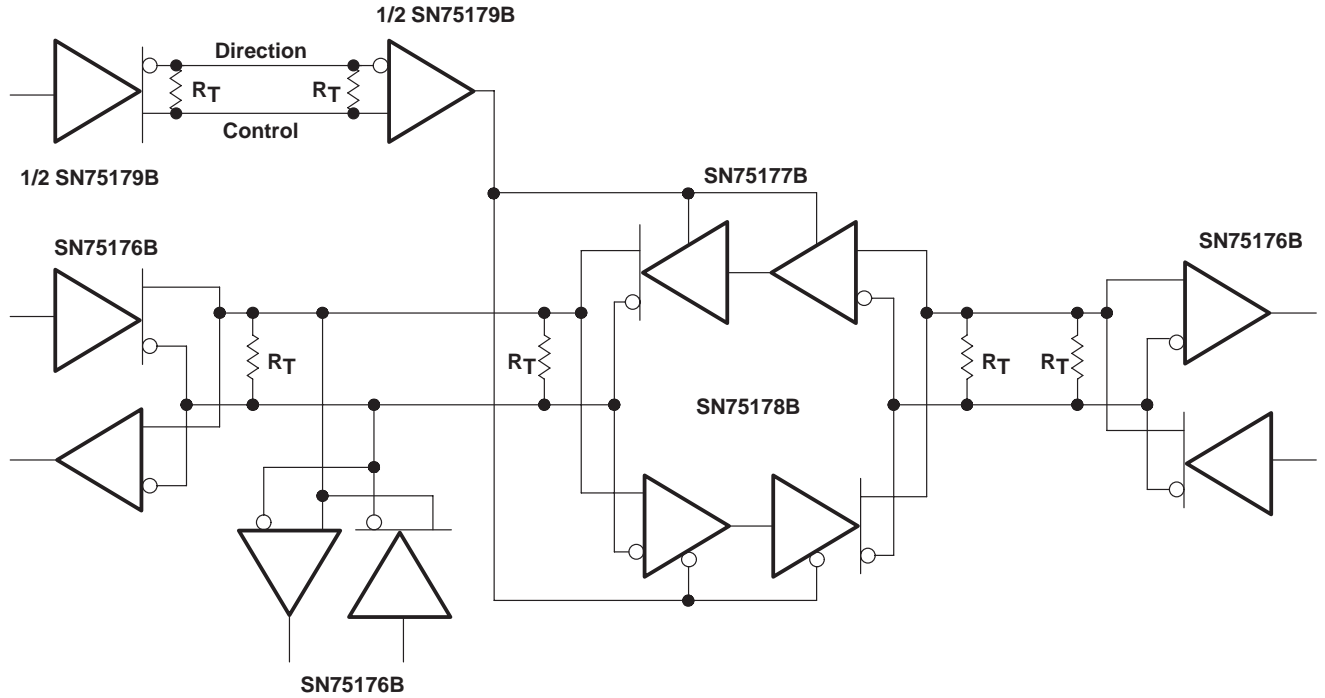

Figure 15

SN75177B, SN75178B DIFFERENTIAL BUS REPEATERS

SLLS002C – D2606, JULY 1985 – REVISED FEBRUARY 1993

APPLICATION INFORMATION



NOTE: The line should be terminated at both ends in its characteristic impedance. Stub lengths off the main line should be kept as short as possible.

Figure 16. Typical Application Circuit

PACKAGING INFORMATION

Orderable Device	Status ⁽¹⁾	Package Type	Package Drawing	Pins	Package Qty	Eco Plan ⁽²⁾	Lead/Ball Finish	MSL Peak Temp ⁽³⁾
SN75177BD	OBSOLETE	SOIC	D	8		TBD	Call TI	Call TI
SN75177BP	OBSOLETE	PDIP	P	8		TBD	Call TI	Call TI
SN75178BD	OBSOLETE	SOIC	D	8		TBD	Call TI	Call TI
SN75178BDR	OBSOLETE	SOIC	D	8		TBD	Call TI	Call TI
SN75178BP	ACTIVE	PDIP	P	8	50	Pb-Free (RoHS)	CU NIPDAU	N / A for Pkg Type
SN75178BPE4	ACTIVE	PDIP	P	8	50	Pb-Free (RoHS)	CU NIPDAU	N / A for Pkg Type
SN75178BPSR	ACTIVE	SO	PS	8	2000	Green (RoHS & no Sb/Br)	CU NIPDAU	Level-1-260C-UNLIM
SN75178BPSRE4	ACTIVE	SO	PS	8	2000	Green (RoHS & no Sb/Br)	CU NIPDAU	Level-1-260C-UNLIM
SN75178BPSRG4	ACTIVE	SO	PS	8	2000	Green (RoHS & no Sb/Br)	CU NIPDAU	Level-1-260C-UNLIM

⁽¹⁾ The marketing status values are defined as follows:

ACTIVE: Product device recommended for new designs.

LIFEBUY: TI has announced that the device will be discontinued, and a lifetime-buy period is in effect.

NRND: Not recommended for new designs. Device is in production to support existing customers, but TI does not recommend using this part in a new design.

PREVIEW: Device has been announced but is not in production. Samples may or may not be available.

OBSOLETE: TI has discontinued the production of the device.

⁽²⁾ Eco Plan - The planned eco-friendly classification: Pb-Free (RoHS), Pb-Free (RoHS Exempt), or Green (RoHS & no Sb/Br) - please check <http://www.ti.com/productcontent> for the latest availability information and additional product content details.

TBD: The Pb-Free/Green conversion plan has not been defined.

Pb-Free (RoHS): TI's terms "Lead-Free" or "Pb-Free" mean semiconductor products that are compatible with the current RoHS requirements for all 6 substances, including the requirement that lead not exceed 0.1% by weight in homogeneous materials. Where designed to be soldered at high temperatures, TI Pb-Free products are suitable for use in specified lead-free processes.

Pb-Free (RoHS Exempt): This component has a RoHS exemption for either 1) lead-based flip-chip solder bumps used between the die and package, or 2) lead-based die adhesive used between the die and leadframe. The component is otherwise considered Pb-Free (RoHS compatible) as defined above.

Green (RoHS & no Sb/Br): TI defines "Green" to mean Pb-Free (RoHS compatible), and free of Bromine (Br) and Antimony (Sb) based flame retardants (Br or Sb do not exceed 0.1% by weight in homogeneous material)

⁽³⁾ MSL, Peak Temp. -- The Moisture Sensitivity Level rating according to the JEDEC industry standard classifications, and peak solder temperature.

Important Information and Disclaimer:The information provided on this page represents TI's knowledge and belief as of the date that it is provided. TI bases its knowledge and belief on information provided by third parties, and makes no representation or warranty as to the accuracy of such information. Efforts are underway to better integrate information from third parties. TI has taken and continues to take reasonable steps to provide representative and accurate information but may not have conducted destructive testing or chemical analysis on incoming materials and chemicals. TI and TI suppliers consider certain information to be proprietary, and thus CAS numbers and other limited information may not be available for release.

In no event shall TI's liability arising out of such information exceed the total purchase price of the TI part(s) at issue in this document sold by TI to Customer on an annual basis.

TAPE AND REEL INFORMATION



QUADRANT ASSIGNMENTS FOR PIN 1 ORIENTATION IN TAPE



*All dimensions are nominal

Device	Package Type	Package Drawing	Pins	SPQ	Reel Diameter (mm)	Reel Width W1 (mm)	A0 (mm)	B0 (mm)	K0 (mm)	P1 (mm)	W (mm)	Pin1 Quadrant
SN75178BPSR	SO	PS	8	2000	330.0	16.4	8.2	6.6	2.5	12.0	16.0	Q1

TAPE AND REEL BOX DIMENSIONS



*All dimensions are nominal

Device	Package Type	Package Drawing	Pins	SPQ	Length (mm)	Width (mm)	Height (mm)
SN75178BPSR	SO	PS	8	2000	346.0	346.0	33.0

IMPORTANT NOTICE

Texas Instruments Incorporated and its subsidiaries (TI) reserve the right to make corrections, modifications, enhancements, improvements, and other changes to its products and services at any time and to discontinue any product or service without notice. Customers should obtain the latest relevant information before placing orders and should verify that such information is current and complete. All products are sold subject to TI's terms and conditions of sale supplied at the time of order acknowledgment.

TI warrants performance of its hardware products to the specifications applicable at the time of sale in accordance with TI's standard warranty. Testing and other quality control techniques are used to the extent TI deems necessary to support this warranty. Except where mandated by government requirements, testing of all parameters of each product is not necessarily performed.

TI assumes no liability for applications assistance or customer product design. Customers are responsible for their products and applications using TI components. To minimize the risks associated with customer products and applications, customers should provide adequate design and operating safeguards.

TI does not warrant or represent that any license, either express or implied, is granted under any TI patent right, copyright, mask work right, or other TI intellectual property right relating to any combination, machine, or process in which TI products or services are used. Information published by TI regarding third-party products or services does not constitute a license from TI to use such products or services or a warranty or endorsement thereof. Use of such information may require a license from a third party under the patents or other intellectual property of the third party, or a license from TI under the patents or other intellectual property of TI.

Reproduction of TI information in TI data books or data sheets is permissible only if reproduction is without alteration and is accompanied by all associated warranties, conditions, limitations, and notices. Reproduction of this information with alteration is an unfair and deceptive business practice. TI is not responsible or liable for such altered documentation. Information of third parties may be subject to additional restrictions.

Resale of TI products or services with statements different from or beyond the parameters stated by TI for that product or service voids all express and any implied warranties for the associated TI product or service and is an unfair and deceptive business practice. TI is not responsible or liable for any such statements.

TI products are not authorized for use in safety-critical applications (such as life support) where a failure of the TI product would reasonably be expected to cause severe personal injury or death, unless officers of the parties have executed an agreement specifically governing such use. Buyers represent that they have all necessary expertise in the safety and regulatory ramifications of their applications, and acknowledge and agree that they are solely responsible for all legal, regulatory and safety-related requirements concerning their products and any use of TI products in such safety-critical applications, notwithstanding any applications-related information or support that may be provided by TI. Further, Buyers must fully indemnify TI and its representatives against any damages arising out of the use of TI products in such safety-critical applications.

TI products are neither designed nor intended for use in military/aerospace applications or environments unless the TI products are specifically designated by TI as military-grade or "enhanced plastic." Only products designated by TI as military-grade meet military specifications. Buyers acknowledge and agree that any such use of TI products which TI has not designated as military-grade is solely at the Buyer's risk, and that they are solely responsible for compliance with all legal and regulatory requirements in connection with such use.

TI products are neither designed nor intended for use in automotive applications or environments unless the specific TI products are designated by TI as compliant with ISO/TS 16949 requirements. Buyers acknowledge and agree that, if they use any non-designated products in automotive applications, TI will not be responsible for any failure to meet such requirements.

Following are URLs where you can obtain information on other Texas Instruments products and application solutions:

Products

Amplifiers	amplifier.ti.com
Data Converters	dataconverter.ti.com
DSP	dsp.ti.com
Clocks and Timers	www.ti.com/clocks
Interface	interface.ti.com
Logic	logic.ti.com
Power Mgmt	power.ti.com
Microcontrollers	microcontroller.ti.com
RFID	www.ti-rfid.com
RF/IF and ZigBee® Solutions	www.ti.com/lprf

Applications

Audio	www.ti.com/audio
Automotive	www.ti.com/automotive
Broadband	www.ti.com/broadband
Digital Control	www.ti.com/digitalcontrol
Medical	www.ti.com/medical
Military	www.ti.com/military
Optical Networking	www.ti.com/opticalnetwork
Security	www.ti.com/security
Telephony	www.ti.com/telephony
Video & Imaging	www.ti.com/video
Wireless	www.ti.com/wireless

Mailing Address: Texas Instruments, Post Office Box 655303, Dallas, Texas 75265
Copyright © 2008, Texas Instruments Incorporated